

SWING DOOR
OPERATOR
for one or two wings

NEPTIS/LE

Nepti  itqel

GB

Installation
Manual





LABEL S.p.A.
Sede: ITALY - 43100 PARMA - S. Pancrazio Pse - Via Ilariuzzi, 17/A
Tel. (+39) 0521/6752 - Fax (+39) 0521/675222
infocom@labelspa.it - web: www.labelspa.it

DECLARATION OF CONFORMITY

Manufacturer: Label S.p. A.

Address: via Ilariuzzi 17/A- 43100 San Pancrazio Parmese. PARMA- ITALY

Declares that: the NEPTIS/LE actuator for swing doors

- ◆ has been designed to be built into machinery or to be assembled with other devices so as to form machinery covered by Machine
- ◆ Directive 98/37/EC and that it conforms to the essential safety requirements of the following directives:
 - Low Voltage Directive 73/23/EEC and successive modification 93/68/EEC
 - Electromagnetic compatibility Directive 89/336/EEC and successive modifications 92/31/EEC and 93/68/EEC

Parma, 15/06/2006

The President
Bruno Baron Toaldo



Bruno Baron Toaldo

CONTENTS

MECHANICAL SECTION	page	4
1.0 ACTUATOR COMPONENTS	"	5
2.0 ARMS	"	5
3.0 GENERAL SAFETY RECOMMENDATIONS	"	6
4.0 MACHINE DIRECTIVES	"	6
5.0 INSTRUCTIONS FOR USE	"	6
6.0 HOW TO PREPARE AND FIX THE ACTUATOR	"	7
7.0 TECHNICAL DRAWINGS	"	8
8.0 ARM CONNECTIONS	"	10
9.0 ARM REMOVAL	"	11
10.0 EXTENSION SHAFT	"	12
ELECTRONIC SECTION	page	15
1) ELECTRICAL CONNECTIONS	"	16
2) DESCRIPTION OF LOGIC PART LGN OF THE CONTROL UNIT	"	18
3) HOW TO RESET THE SPRING PRELOAD	"	19
4) HOW TO SET THE DEVICE AT WORK (INITIAL SET-UP)	"	20
4.1) HOW TO CANCEL A PREVIOUS INITIAL SET-UP	"	20
5) MANUAL FUNCTION SELECTORS	"	21
5.1) FUNCTION SELECTOR SWITCH	"	21
5.2) MANUAL SELECTOR	"	21
5.2.1) ELECTRICAL CONNECTIONS	"	21
5.2.2) OPERATING MODES	"	21
6) FUNCTIONS OF DIP SWITCH S1	"	22
7) FUNCTIONS OF DIP SWITCH S2 (only via digital selector)	"	23
8) POTENTIOMETER ADJUSTMENTS	"	24
9) DIGITAL SELECTOR	"	25
9.1) THE REMOTE CONTROL	"	26
9.2) ADJUSTING THE DEVICE WITH REMOTE PROGRAMMING VIA SELECTOR	"	27
10) COURTESY MODE FOR THE DISABLED	"	28
11) ELECTRO-LOCK RELEASE WITH FREE DOOR	"	28
12) PHOTOCCELL BOARD	"	28
13) SWING DOOR WITH TWO WINGS	"	30
13.1) ELECTRICAL CONNECTIONS	"	30
13.1.1) ACTUATOR WITH MASTER CONTROL UNIT	"	31
13.1.2) ACTUATOR WITH SLAVE CONTROL UNIT	"	31
13.2) HOW TO INSTALL THE DEVICE	"	31
13.3) FUNCTIONS AND ADJUSTMENTS	"	32
13.3.1) HOW TO ADJUST THE MASTER ACTUATOR	"	32
13.3.2) HOW TO ADJUST THE SLAVE ACTUATOR	"	32
13.3.3) HOW TO CHECK THE WAY THE DOOR OPERATES	"	32
14) PEDESTRIAN OPENING	"	33
15) LIST OF PARAMETERS TO SELECT FOR THE CONTROL UNITS	"	33
16) MEANINGS OF THE BUZZER SIGNALS (BEEPS)	"	34
17) TECHNICAL SPECIFICATIONS	"	34
18) ADVANCED FUNCTIONS - TECHNICAL MENU	"	35

MECHANICAL SECTION

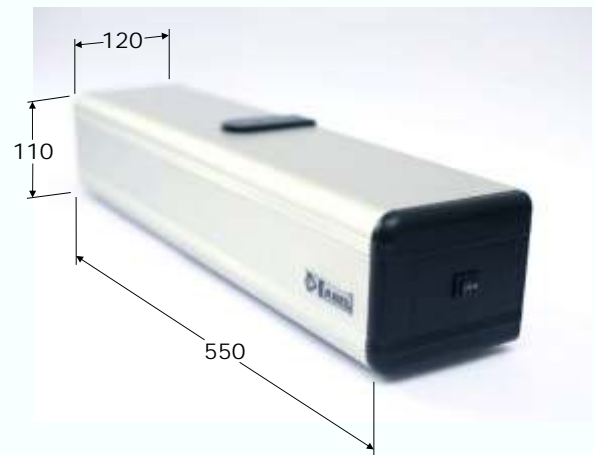
NEPTIS/LE



1.0 ACTUATOR COMPONENTS

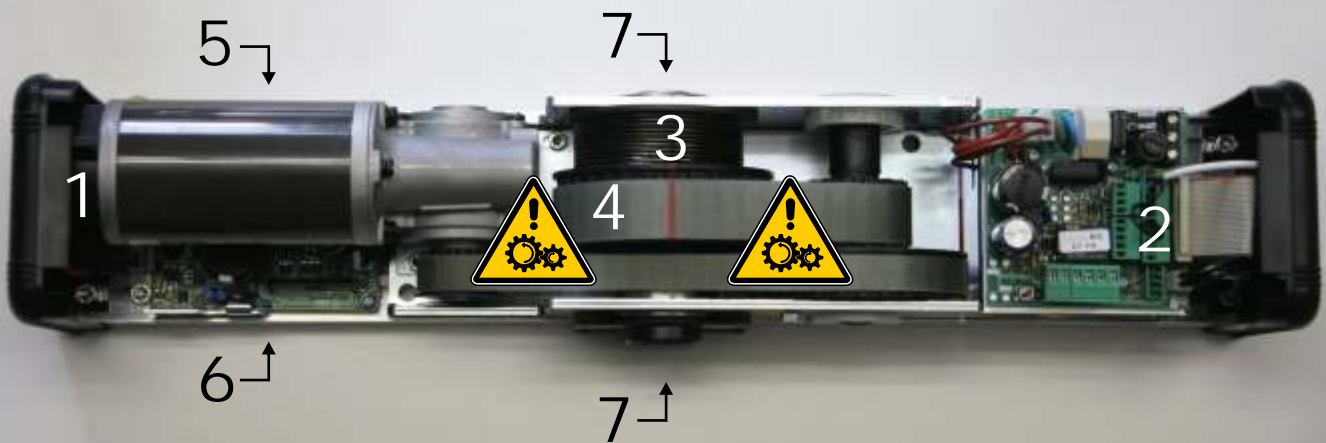

- 1-Regulating dip-switches and potentiometers
- 2-Powering board and connections
- 3-Spring
- 4-Spring preload reference

- 5-Keypad board housing
- 6-Photocell board housing
- 7-Projecting pin
- 8-Spring locking screw



2.0 ARMS



SLIDING ARM



ARTICULATED ARM

3.0 GENERAL SAFETY RECOMMENDATIONS

Only begin to install the actuator after you have carefully read this instruction manual.

Both the mechanical part and the electrical part must be installed in a perfectly workmanlike manner, in compliance with the current laws in force. Failure to comply with these latter may result in danger hazards for persons or property.

The installer must be a competent person who has been adequately trained. He must check to make sure that the structure on which the actuator is installed is strong and stable. If necessary, structural modifications must be made to strengthen it.

The installer must also check that all zones where there is a risk of crushing, dragging, shearing or other dangers, are protected by means of electronic safety devices, safety freeboards or barriers. These devices must be installed in compliance with the current laws and in a perfectly workmanlike way, also in relation to the place of use, the type of use and the operating logic of the product. The forces developed by the complete system as it operates must comply with the current standards and, where this is not possible, the zones affected by these forces must be protected with electronic safety devices.

Moreover, dangerous zones must be indicated, as established by the current laws in force.

Before the actuator is connected, make sure that the electricity main possesses characteristics that are compatible with those described in the technical specifications of this manual, and that there is a differential circuit-breaker and adequate protection against overcurrents on the supply side of the system. Remember to turn off the power supply before installing or servicing the actuator and whenever the cover must be opened.

Electrostatic charges can damage the electronic components on the boards. Wear a grounded antistatic bracelet if you must work on the electronic boards. Never place the hands or other parts of the body in moving parts, such as belts, pulleys, gears, etc.

Servicing the actuator is of fundamental importance if the system is to operate correctly and safely. Comply with the manufacturer's instructions described in this manual when servicing the actuator.

The manufacturer declines all liability for improper installation or use of the product, or for damage deriving from unauthorized modifications to the system. Only use genuine spare parts if replacements or repairs are required. The manufacturer cannot be held liable for the way the doors or gates to be automated are constructed, or for damages caused by failure to build the doors and gates in compliance with good workmanlike techniques.

Protection degree IP22 requires that the actuator only be installed inside buildings. The manufacturer declines all liability for damage caused by assembly on the outside, without adequate protections.

Always make sure that the product is in a good condition before it is installed.

This product cannot be installed in places with an explosive atmosphere or in the presence of inflammable fumes or gases.

This product must be disposed of according to the current laws in force at the end of its useful life.

Do not leave parts of the product or its packaging within children's reach, as they could become a danger hazard.

4.0 MACHINE DIRECTIVE

As established by the EU commission, automated pedestrian closing systems are governed by the machine directive (98/37/EC). This latter specifies that the installer who fits a driving system on a door or gate has the same obligations as the manufacturer of the machine. Thus, he must:

1. Prepare the technical report (complete with the documents described in annex V of the Machine Directive).
2. Compile the relative CE conformity certificate (as per annex II-A of the Machine Directive).
3. Affix CE marking to the motorized door or gate (1.7.3, of annex I of the Machine Directive).

The installer must keep the technical report at the disposal of the competent authorities in the country for at least 10 years, running from the date on which the motorized door or gate was manufactured.

The installer must consign the following documents to the customer:

1. Instructions on how to operate and safely use the system.
2. The routine maintenance instructions.
3. The declaration of conformity.
4. The maintenance register.

5.0 INSTRUCTIONS FOR USE

The "NEPTIS/LE" actuator is suitable for continuous service. The maximum weight of the wing it drives depends on the actual wing itself, on the type of arm and on the type of fixing mechanism (POWER or SPEED).

Consult the tables in chapter 6, depending on the application used.

The specifications described above refer to a typical installation and may be substantially influenced by the variables in every installation, such as friction, balancing, environmental conditions, etc.

6.0 HOW TO PREPARE AND FIX THE ACTUATOR

Before fixing the actuator and arms, first make sure that the relative bearing structure is strong and secure, that the door has adequate hinges, that it is not subjected to friction that could prevent the system from operating correctly and that the points where the arm is fixed to the wing are strong enough.

If necessary, these points must be reinforced in an adequate way (additional plates, stronger hinges, etc.).

The door needs a floor stop to keep it open so as to prevent the mechanisms from being damaged if it is pulled violently open by hand. The floor stop is not supplied with the actuator and must be procured by the installer.

Remove the actuator from its wrapping and make sure that it is in a perfect condition.

Remove the screws that hold the cover in place.

Remove the aluminium cover from its housing by pulling strongly upwards, without pressing on the sides if possible.

The arm can be connected to either side of the mechanical body of the actuator. This means that the direction of the opening movement can be selected. The connection side of the arm is identified by the label on the mechanical body. This shows the opening direction of the pin. Bear in mind which type of arm (either sliding or articulated) and fixing method (on the wall or wing) will be used.

The actuator has two closing plugs for the pin outlets, of which one is broken through to allow the pin to pass while the other remains whole. Switch them if the arm connection uses the shaft outlet with the whole plug.

The following pages describe the ways in which the actuator is used, with both the articulated arm and sliding arm.

There are two tables for each type of fixing method, one called "SPEED" and the other called "POWER".

The basic difference between the two is the distance at which the actuator is fixed in relation to the wing hinge, which either achieves more speed and less power ("SPEED") or more power and less speed ("POWER").

Comply with the tables for the distance measurements and holes to make, or use the drilling templates in scale 1:1 supplied with the arms.



ARTICULATE PUSH ARM

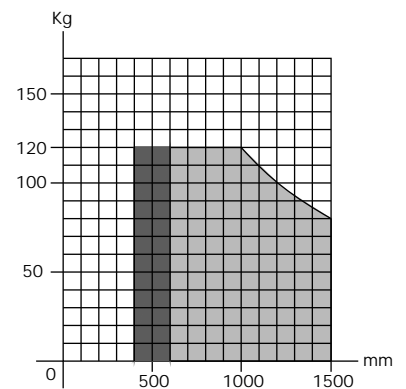
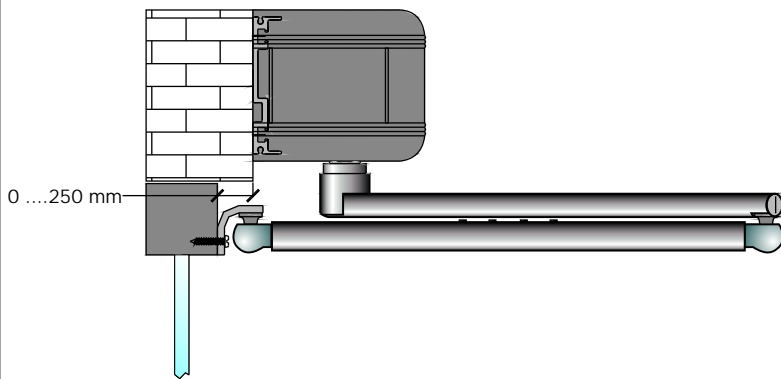
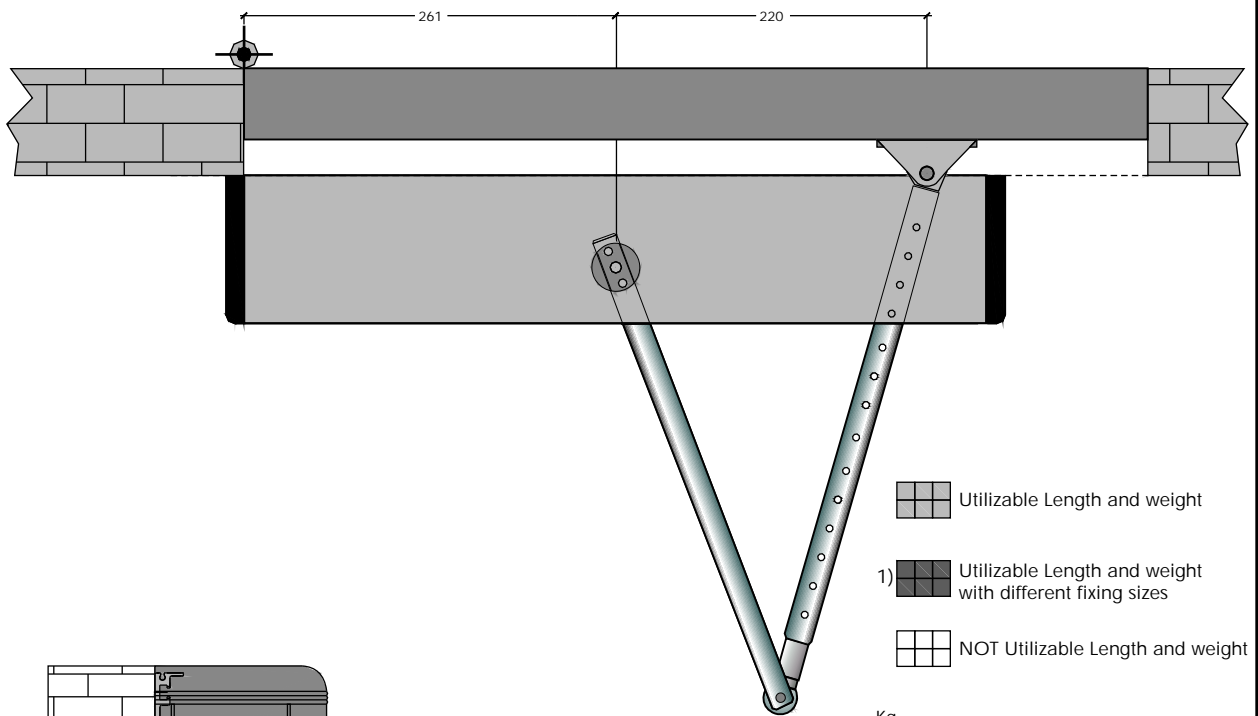
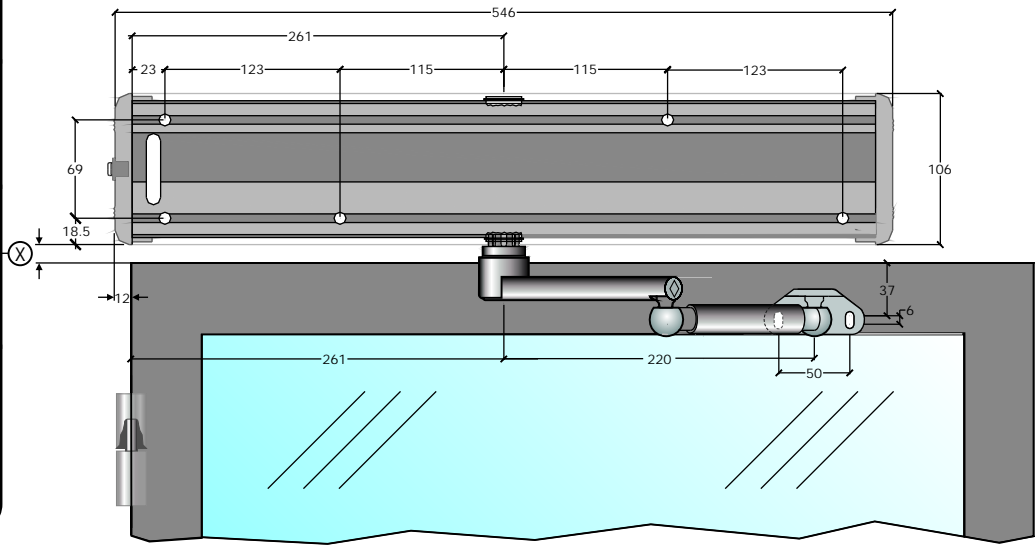
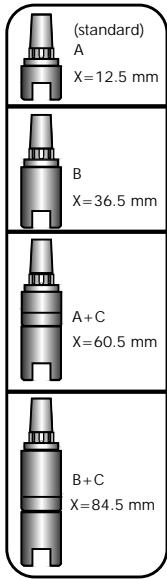

1) Fixing drawings available on request

SLIDE PULL ARM

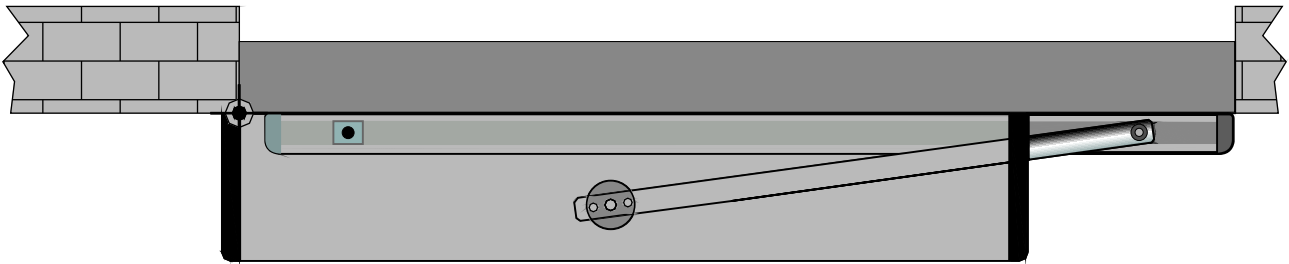
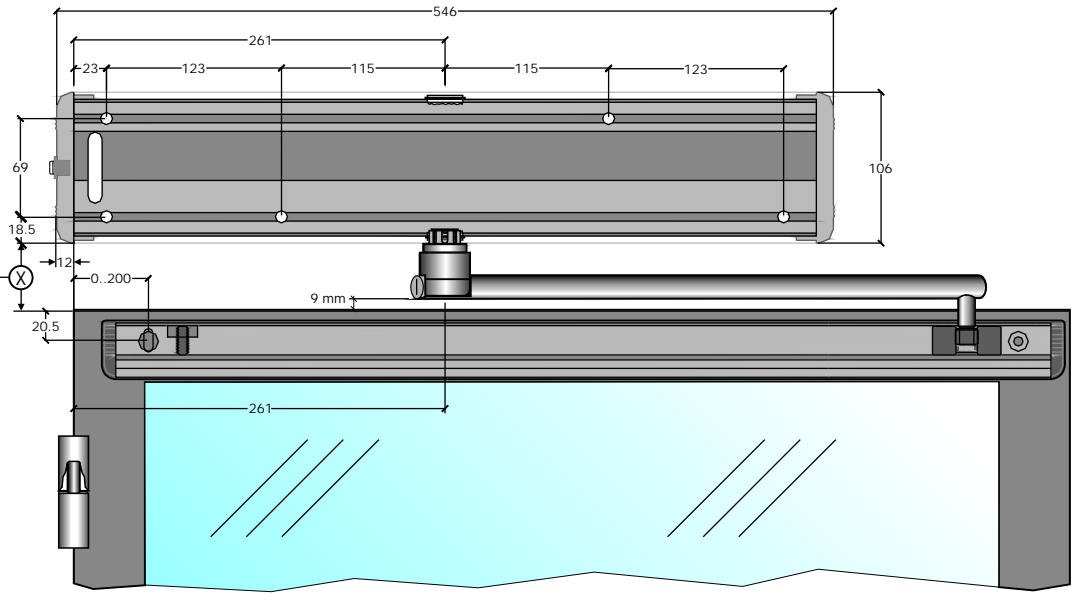
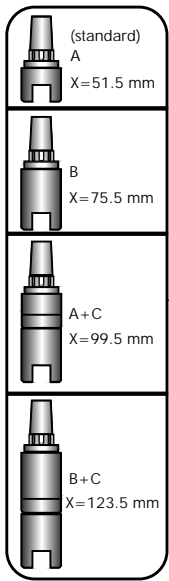

Utilizable Length and weight

1) Utilizable Length and weight with different fixing sizes

NOT Utilizable Length and weight

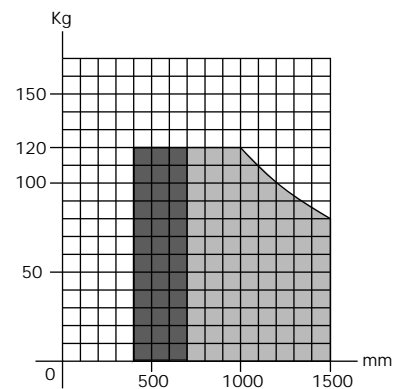
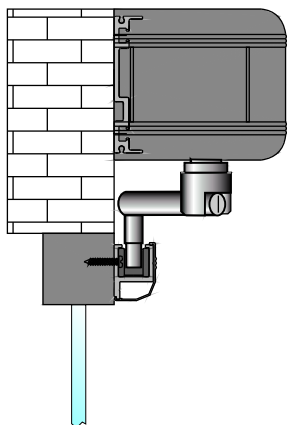

1) Fixing drawings available on request

8.0 ARM CONNECTION

Warning: strictly comply with the steps described when fixing the arms. Only remove the spring preload locking screw when specified in the instructions. Removal of the spring preload locking screw causes the pulleys and gears in the actuator to move. Keep your fingers and other parts of the body well away from the moving parts during this operation!

Only carry out this operation after having disconnected the actuator from the electric power source. After having fixed the actuator and arm as shown in the diagrams on the previous pages (or using the drilling template in scale 1:1 supplied with each arm), connect the arm to the output shaft of the actuator as described in the following steps:

8.1 Choice of the spring load

The closing spring will have been preloaded in the factory with a standard value, indicated by the red mark on the belt which matches the red mark on the pulley (see figure alongside). Make sure that this condition has been complied with when the product is installed. If this is not the case, comply with the instructions in chapter 3) on page 21 in order to bring the preload back within the standard value.

Although the preload is fixed, the power exercised by the spring during the closing phase can be selected in the following way:

Connect the arm to the output shaft with the wing fully open so as to load the spring to the minimum.

Connect the arm to the output shaft with the wing fully closed so as to load the spring to the maximum.

Connection in an intermediate position loads the spring to a proportionally intermediate value.

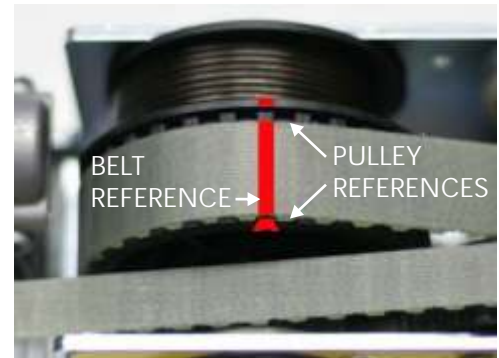

8.2 How to fix the tapered end of the arm

Make sure that the puller nut screwed into the tapered end is positioned fully downwards, as shown in the figure.

Make sure that the hole plug has been fitted on the frame.

Connect the tapered end of the arm to the projecting pin.

Insert the fixing screw and tighten it strongly.



8.3 Spring release

Warning:

When this operation is carried out, the components and door arm could start to move. Keep your fingers and other parts of the body well away from moving parts during this operation, or keep the wing blocked manually.

Move the spring locking screw from the locked position to the released position, as described in the figure alongside. The door is now free to close by means of the spring. Make sure that the door closes completely even when only open to a few degrees. If this fails to occur, repeat the operations described in this chapter, but increase the closing force as illustrated in section 8.1. Comply with the instructions in the following section to disconnect the arm.



9.0 ARM REMOVAL

Warning:

Strictly comply with the steps described when removing the arms. Only remove the screw that fixes the tapering pin and tighten the puller nut when specified in the instructions. Removal of the screw that fixes the tapered pin and use of the puller nut may cause the pulleys and gears in the actuator to move unless the closing spring has been previously locked. Keep your fingers and other parts of the body well away from the moving parts during this operation!

9.1 How to restore the standard preload and lock the spring

Before you remove the arm, you must restore the spring load to its standard value, whereby the red mark on the belt matches the red mark on the pulley (see figure alongside), and lock the spring in this position. To do this, move the door by hand until this condition has been obtained and the red marks on the belt and pulley match.

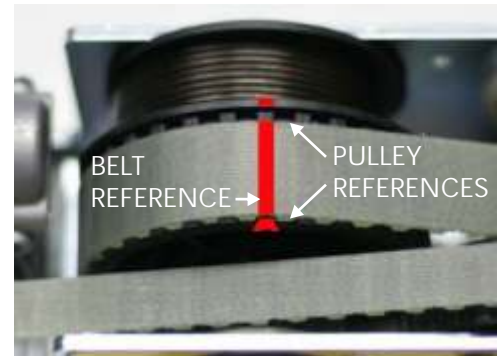

Move the locking screw from the free position to the locked position and make sure that the screw fits into the locking hole in the pulley.

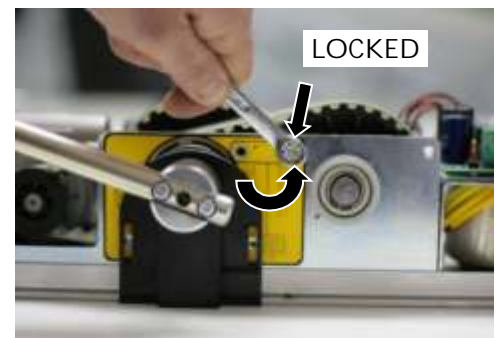

9.2 How to extract the tapering pin

Remove the fixing screw from the tapering pin.



Tighten the release nut upwards until the pin has been completely removed.

10.0 EXTENSION SHAFT

Where the conical shaft height should be not sufficient for the application,

Is available an extension shaft (optional) to increase this height.
For available heights refer to paragraph 7.0

First of all disconnect the arm from the conical connection by unscrew the two head screws.



Set the extension shaft in the conical connection like in figure.
Remember to keep the main screw inside conical connection.



Fix the extension shaft on the conical connection by two screw supplied with the extension.

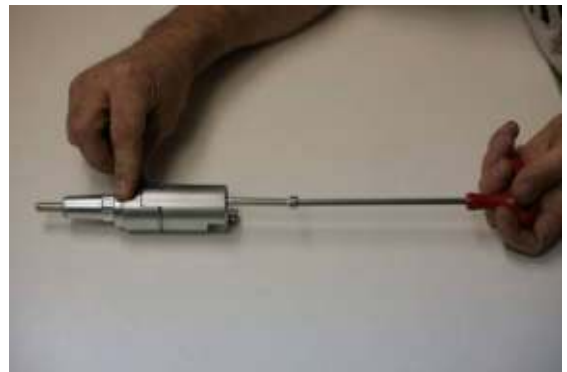

Set the arm on the extension and fix to it by the two original screws.



About arm connection and arm removal refer to previous paragraphs.

MAINTENANCE PROGRAM

Maintenance program for swing door NEPTIS/LE:

Each 6 month:

! Attention- Before work on the operator cut main power line.

- Check that all securing screws are well tightened.
- Clean and lubricate moving and sliding components.
- Lubricate closing spring if present.
- Check wiring connections.
- Check that arm connection screw are well tightened.
- Check that door leaf are stable and the movement is steady, without friction from full open to full close position.
- Check the condition of the hinges and lubricate it.
- Check that speeds, timing, and safety functions are well adjust.
- Check that safety and activation sensor are properly functioning.

!Attention-Any part that appear damaged or worn must be changed.

For spare parts see the spare part list.

NEPTIS/LE

ELECTRONIC SECTION



1) ELECTRICAL CONNECTIONS

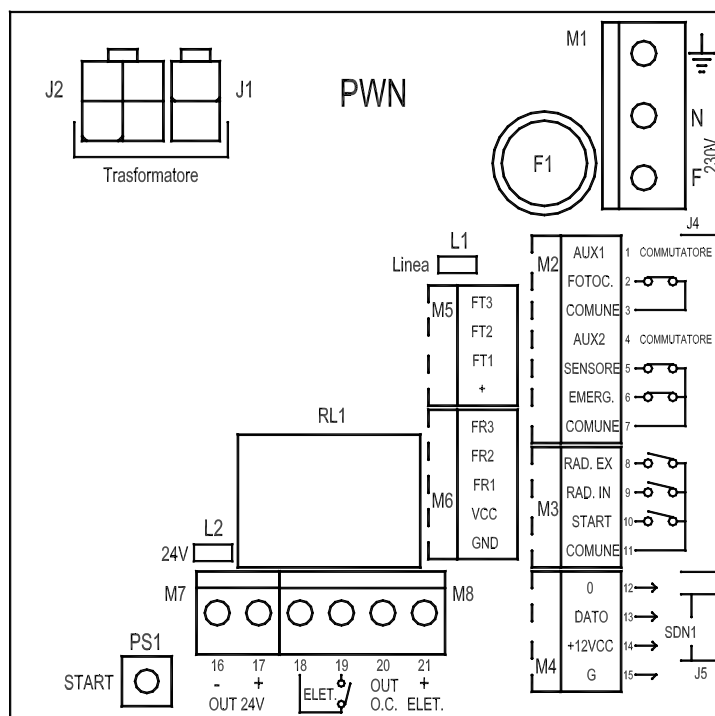
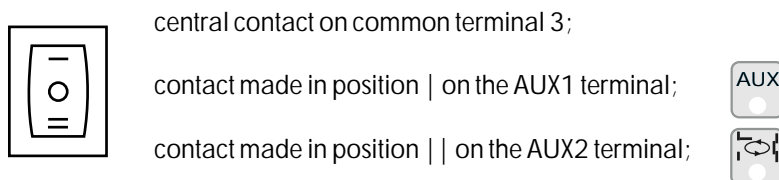



Fig. 1

- **TERMINAL BOARD M1**
230 V.a.c. power supply: phase wire to terminal F, neutral wire to terminal N + ground connection. The line is protected by the 5A fuse F1.
- **TERMINAL BOARD M2**
Terminals 1-3-4 = connection of the FUNCTION SELECTOR switch installed on the side of the device.



Terminals 2-3  = N.C. input of the safety PHOTOCCELL.
 Activates during the closing phase and reverses the door's direction.

Terminals 5-7  = N.C. input of the opening safety SENSOR mod. SSS1.
 The door stops if an obstruction or person is detected, and only starts opening again when the sensor has been released.

Terminals 6-7  = EMERGENCY N.C. input. Opens the door in any condition.

Can also operate in the stepping mode (see sect. 7).

- TERMINAL BOARD M3

Terminals 8-11  = N.O. EXTERNAL RADAR input. Commands the door opening function.
It is excluded by the digital selector in the *night lock* or *exit only* functions.
It is excluded by the manual selector in the *night lock* or *exit only* functions.
Can also operate as an opening only input (see sect. 7).

Terminals 9-11  = N.O. INTERNAL RADAR input. Commands the door opening function.
It is inhibited by digital selector in the *night lock* or *entrance only* functions.
It is inhibited by manual selector in the *night lock* function.
Can also operate as a closing only input (see sect. 7).

Terminals 10-11  = N.O. START input. Commands the door opening function and starts the initial set-up.
It is inhibited by digital selector in the *night lock* function.
It is inhibited by manual selector in the *night lock* function.
Can also operate in the stepping mode (see sect. 7).

- TERMINAL BOARD M4

Connection to digital selector. Use a 4-pole flex (0.5 mm in diameter), maintaining the same signal match between selector and control unit. Maximum cable length 20 meters.

Route the connection cable well away from sources of electrical interference to prevent false displays on the selector.

Terminal 12 = 0 (powering negative)
Terminal 13 = DATA ITEM
Terminal 14 = +12 Vdc (powering positive)
Terminal 15 = G (ground)

Use the 4-pin terminal board in the selector kit.

WARNING!

The selector kit includes the "LOGIC TAST" interface board, which must be fitted into connector J8 (see fig. 2) so as to allow the selector to work with the "NEPTIS/LE" control unit.

- TERMINAL BOARDS M5-M6 = Dedicated to connection of photocell PRJ38 capsules; see sect. 12 for operation mode.
- TERMINAL BOARD M7

Terminals 16 (-)-17(+) = 24 Vdc output, max. 20 W, for powering external accessories.

Led L2 indicates that the line is powered a 24V.

- TERMINAL BOARD M8

Terminals 18-19 = N.O. clean contact of relay RL1 that can be used to connect an electro-lock.

Take the power from terminals 16 (-) and 21 (+) in the case of a 24 V electro-lock.

Terminal 20 = Signal output of the OPEN COLLECTOR type, active when door is open or moving; max. load 100mA.

The positive signal is taken from terminal 17.

Connector 16 (-) e 21 (+) = output 24Vdc for the powering of the electrolock (24V).

CONNECTORS J1-J2 = power transformer connection: primary on J1, secondary on J2.

CONNECTORS J4-J10 = wiring of signal conductors between electrical connection part PWN and logic logic part LGN of the electronic control unit.

CONNECTORS J5-J11 = connection of the powering conductors between the parts PWN e LGN of the control unit..
The powering line LGN is visualized by the LED L1.

CONNECTOR J6 = encoder connection.

CONNECTOR J7 = motor connection.

2) DESCRIPTION OF LOGIC PART LGN OF THE CONTROL UNIT

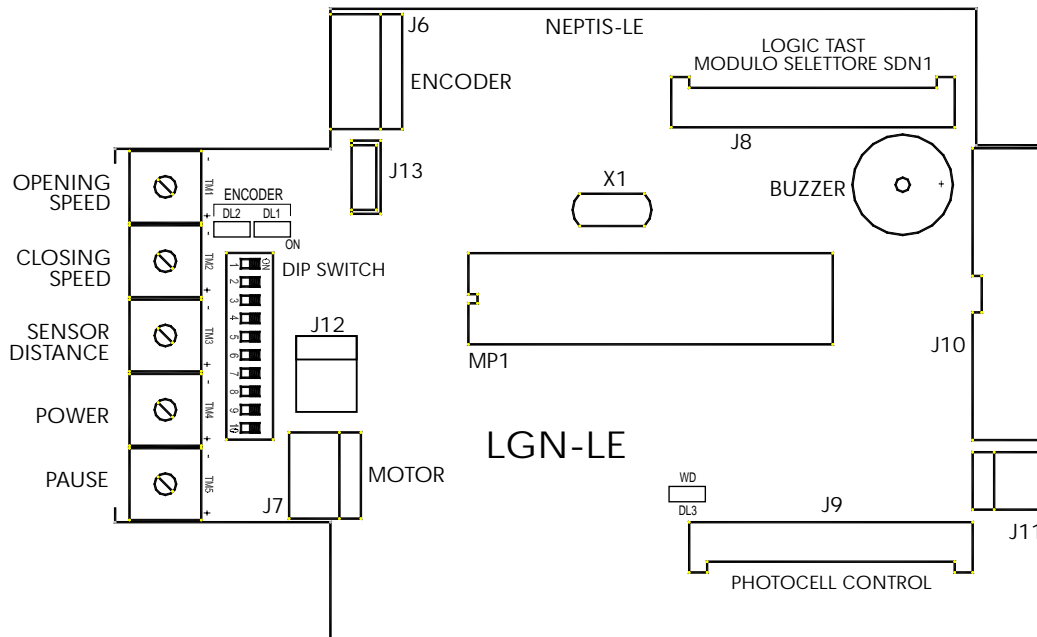

Fig. 2

- DL1 DL2 = display the signals from the encoder's sensor.
 DL3 = indicates that main microprocessor MP1 is operating correctly by flashing very fast.
 If the led is off or flashes slowly, this means that the logic board is faulty.
- CONNECTOR J8 = connection for the LOGIC TAST interface module of selector.
 CONNECTOR J9 = connector for the photocell board.
 CONNECTOR J13 = connection between the MASTER and the SLAVE control unit for two-wing swing door
 (see sect. 13). Use the MASTER/SLAVE wiring for "NEPTIS/LE" mod.WR3MS.
- CONNECTOR J8 = connection for the LOGIC TAST interface module of selector.
 CONNECTOR J9 = connector for the photocell board.
- Dip switch S1 = selects the operating programs of the control unit (see sect. 6).
 Potentiometer = calibration of the operating parameters (see sect. 8).
- Buzzer = horn.
 MP1 = microprocessor with label indicating the software version.
- BRIDGE J12 = it selects the speed of closing of the door in absence of main power:
 OPEN BRIDGE = high speed
 CLOSED BRIDGE = low speed

3) HOW TO RESET THE SPRING PRELOAD

Only read this section if, during the installation phase, the arm is accidentally disconnected without the spring being returned to the standard position and relocked. If this happened, the spring would be relieved well beyond its preset level.



The actuator is supplied with the reclosing spring preloaded with a standard value, whereby the red mark on the belt matches the red mark on the pulley (see figure alongside).

If, during operation, the arm is accidentally disconnected without the spring having been returned and locked in the standard position, this latter will relieve well beyond its standard value.

Strictly comply with the following instructions to return the spring to the correct position:

- a) Completely disconnect the arm from the projecting pin if this latter is still inserted.
- b) Make sure that the FUNCTION SELECTOR switch alongside the actuator is in the central "O" position.

If the manual selector is installed, set the knob to the door free position .

If the digital selector is installed, make sure that indicator lights  and  are off.

- c) Carefully move power limiting potentiometer Tm4 to about half of its travel and power the control unit.
- d) Set dip-switch 6 of Minidip S1 to the OFF position.
- e) Switch off the mains power supply (230V) for about 5 seconds.
- f) Turn on the mains power again and wait for an acoustic signal ("BEEP").
- g) Set dip-switch 6 of Minidip S1 to the ON position.
- h) Switch off the mains power supply (230V) for about 5 seconds.
- i) Turn on the mains power again and wait for an acoustic signal ("BEEP")
- j) Set dip-switch 6 of Minidip S1 to the OFF position.
- k) Switch off the mains power supply (230V) for about 5 seconds.
- l) Turn on the mains power again and wait for an acoustic signal ("BEEP")
- m) Press button PS1 (START) on board PWN. The control unit will issue 5 beeps and will begin the spring loading manoeuvre in the constant pressure mode (the movement will stop when the start button is released and will continue when start is pressed again).
- n) Bring the spring load back to the standard value shown when the red mark on the belt matches the red mark on the pulley (see figure alongside), then lock the spring in this position.
- l) Move the locking screw from the free position to the locked position, making sure that it fits into the locking hole on the pulley.

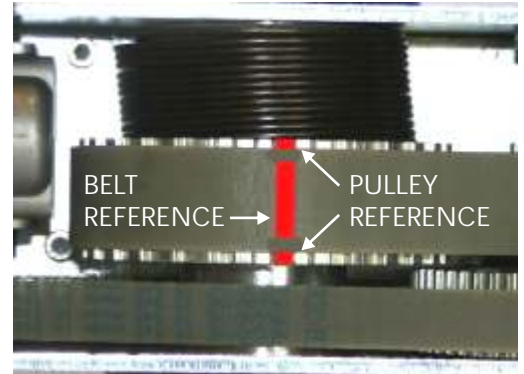

m)!! WARNING, the INITIAL SET-UP will be cancelled after these operations and will therefore have to be made again at the appropriate time, as described in section 4.

4) HOW TO SET THE DEVICE AT WORK (INITIAL SET-UP)

After having fixed the device to the door and loaded the spring (only for the SW version), move the wing as far as it will go by hand. Make sure that the movement is smooth, fluid, without friction and that it ends with the door fully against an end rabbit. Proceed with the initialization phase (initial set-up). This operation is obligatory as it allows the control unit to acquire the stop points. Strictly comply with the following instructions:

- a) Make sure that the device is not powered and that the dip-switches of S1 are in the OFF status.
- b) Move dip-switch 6 of S1 to the ON position and the FUNCTION SELECTOR switch to " | " (day functions).
- c) Move dip-switch 4 of S1 to the ON position, but only if the electro-lock is installed.
- d) Set the door to the closing status.
- e) Power the device: the power unit gives 3 bips, the last two immediately following one another.

WARNING!

During the initial set-up, the door moves with more force than the normal operating conditions. Proceed with care and keep well clear of the door's operating range.

- f) Press button PS1 (start input) on board PWN.
- g) if dip 5 OFF (closing only by spring): the door will complete a full opening cycle at slow speed. Once this manoeuvre has terminated, a prolonged BIP will indicate that the procedure has ended. Door closing occurs at the end of the pause time.
if dip 5 ON (closing by spring and by motor) : the door will push lightly closed and will then proceed with a complete opening / closing cycle at slow speed. Once the door has closed, a prolonged BIP will indicate that the procedure has ended.

IMPORTANT: during the initializing phase, there must be no obstructions in the manoeuvring area and the door must not be helped along by hand.

Once the initial set-up has terminated, make an opening manoeuvre by means of a command input and check the movements according to the default settings.

SAFETY: The thrusting force of the door can be checked during the starting phase and at various stages of its movement by listening to the buzzer and the indications given by the warning light  of digital selector. The effective intensity of this thrusting movement can be checked by obstructing the movement in order to stop the door and reverse its direction. Potentiometer TM4 on board LGN can be used to vary the power of the door thrusting action and to accurately set the required activation limit.

A brief signal from the buzzer during the starting up phase only, indicates that the thrusting power setting is good. Set dip-switch 6 of S1 to the OFF position to inhibit the power limiting buzzer.

Lastly, select the required functions, set the speed, time settings and distances to optimize the operation of the door to suit personal requirements.

4.1) HOW TO CANCEL A PREVIOUS INITIAL SETUP

If wing travel, door weight or spring loading are changed, the initializing phase of the control unit must be repeated. Proceed in the following way:

1. Disconnect the power source, then set dip-switch 6 of S1 to the OFF status and power the control unit.
2. After the initial bip, set dip-switch 6 of S1 to the ON status and disconnect the power source.
3. Power the control unit, wait for the initial bip and set dip-switch 6 of S1 to the OFF status.
4. Shut off the power supply;
5. The previous initial setting will be cancelled;
6. Repeat the previous operations from point a) to point g) to enter the initial setup again.

5) MANUAL FUNCTION SELECTORS

5.1) FUNCTION SELECTOR SWITCH

The door operating program of the device can be chose by means of the FUNCTION SELECTION switch installed on the side of the automatism.

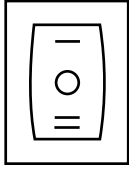

Status “|” = DAY FUNCTIONS
All the command inputs are activated.

Status “O” = DOOR FREE.
The motor is not powered and the door can be moved by hand.

Status “||” = NIGHT LOCK (with dip-switch 7 of S1 in the OFF position).
The door can only be opened with the EMERGENCY input.
DOOR OPEN (with dip-switch 7 of S1 in the ON position).
Door open condition.

5.2) MANUAL SELECTOR

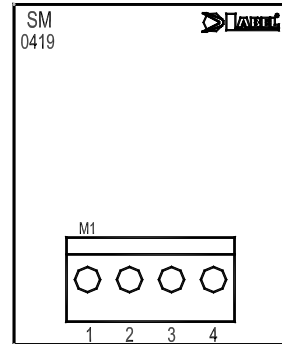
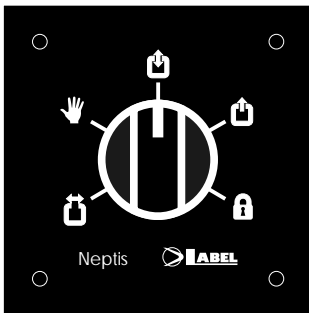

Manual selector is used to enter the operating program of the "NEPTIS/LE" door.

WARNING





When manual selector is used, keep the function selector switch at the side of the device in the "O" position and move dip switch 7 of S1 in the OFF position. This prevents conflict amongst the functions in manual selector and the functions set in the switch built into the actuator itself. If the function selector is liable to be accidentally operated, it is advisable to disconnect it from the terminal board of the "NEPTIS/LE" unit.

5.2.1) ELECTRICAL CONNECTIONS

TERMINAL 1 = connect to input 9 (INTERNAL RADAR) of the PWN of the "NEPTIS/LE" control unit;
TERMINAL 2 = connect to input 3 (COMMON CONTACT) of the PWN of the "NEPTIS/LE" control unit;
TERMINAL 3 = connect to input 1 (AUX1) of the PWN of the "NEPTIS/LE" control unit;
TERMINAL 4 = connect to input 4 (AUX2) of the PWN of the "NEPTIS/LE" control unit.

5.2.2) OPERATING MODES











Turn the knob of manual selector SMN to select the desired function from amongst the 5 available ones

-  DOOR ALWAYS OPEN = to keep the door completely open.
-  DOOR FREE = to move the door in the manual mode without it being controlled by the motor.
-  TRAFFIC IN BOTH DIRECTIONS = to open the door by means of all the command inputs.
-  EXIT TRAFFIC ONLY = to cut out EXTERNAL RADAR input detection.
-  NIGHT LOCK = to keep the door shut, allowing it to be opened with the EMERGENCY input only.

6) FUNCTIONS OF DIP SWITCH S1

Select the functions by means of dip-switch S1 of the control unit or by means of the indicator light  of the digital selector (consult sect. 9.2 for the settings of digital selector).

Selector / Control unit

-  DIP 1 ON = Push & Go activated. Door opened in the manual mode.
OFF = Push & Go inhibited.
-
-  DIP 2 ON = Wind stop activated. Prevents the door from opening accidentally in a draught
OFF = Wind stop inhibited.
-
-  DIP 3 ON = cyclic function activated (repeated door opening and closing).
OFF = cyclic function inhibited.
-
-  DIP 4 ON = electro-lock output activated (see sect.8 for a description of potentiometers TM9 & TM10 which allow operation with the electro-lock to be optimized).
OFF = electro-lock output inhibited.
-
-  DIP 5 ON = OPENING BY MOTOR, CLOSING BY SPRING AND MOTOR.
This function is recommended for doors that may be subjected to wind force when closing and for all those situations in which the force of the spring alone may not be sufficient to guarantee that the door fully closes.
OFF = OPENING BY MOTOR, CLOSING ONLY BY SPRING.
- WARNING!!** : This DIP switch must be set prior to the INITIAL SETUP described in chapter 4.
-
-  DIP 6 ON = activated the initial set-up cycle (see sect.4);
allows power limitation to be indicated by the buzzer.
OFF = inhibits the buzzer warning for power limitation.
-
-  DIP 7 ON = door open condition with function selector in the " | | " position.
OFF = night lock condition with function selector in the " | | " position.
-
-  DIP 8 ON = courtesy function for the disabled. See section 10 for a description of operation.
OFF = courtesy function inhibited
-
-  DIP 9 ON = if the operation program NIGHT LOCK is selected, the door opens and remains open 10" before closing again.
OFF = if the operation program NIGHT LOCK is selected, the door does not open.
In NIGHT LOCK, the door can only be opened with the EMERGENCY input, or with the SPYCO radio control.
-
-  DIP 10 ON = automatically increases the pause time if the door cannot close on account of the high flow of persons
OFF = constant pause time.

DIP 11 (can only be selected with digital selector) 

- ON = work program selected by means of digital selector (see sect. 9).
OFF = work program selected by means of the function selector switch (see sect. 5.1) or the manual selector (see sect. 5.2).

DIP 12 (can only be selected with digital selector) 

- ON = enables regulation of the functions (dip-switch S1) and potentiometers (from TM1 to TM5) by means of digital selector.
OFF = enables regulation of the functions (dip-switch S1) and potentiometers (from TM1 to TM5) by means of control unit LGN.

All the adjustments to dipswitch S2, potentiometers TM6, TM7, TM8, TM9, TM10 and to the TECHNICAL MENU are made by means of digital selector alone.

7) DIP SWITCH S2 FUNCTIONS (only via digital selector)

Set up the functions by means of the indicator light  of digital selector (see sect.9.2).



DIP 1 ON = STEPPING function activated. One pulse opens and a seconde pulse closes
The START and EMERGENCY inputs anre enabled.

DIP 1 OFF = STEPPING function inhibited.



DIP 2 ON = ELECTRO-LOCK RELEASE WITH FREE DOOR ENABLED.
Consult sect. 11 for a description of this operating mode.

OFF = ELECTRO-LOCK RELEASE WITH FREE DOOR DISABLED



DIP 3 (only activated if DIP 4 = ON)

ON = PEDESTRIAN OPENING WITH SELECTOR ON  (see sect. 14)

OFF = PEDESTRIAN OPENING WITH SELECTOR ON  (see sect. 14)



DIP 4 ON = PEDESTRIAN OPENING ENABLED (see sect. 14)

OFF = PEDESTRIAN OPENING INHIBITED (see sect. 14)



DIP5 = DELAY ON STARTING FOR TWO-WING SWING DOOR (see sect. 13).
Adjustment required if wings overlap.

ON = WING DELAY ACTIVATED IN BOTH OPENING AND CLOSING PHASES.

The MASTER/SLAVE units operate with a preset wing delay time which can be changed by means of digital selector, accessing the TECHNICAL MENU and modifying the parameters in points 13 (wing delay on opening) and 14 (wing delay on closing). Consider that the MASTER unit is delayed, while the SLAVE unit is delayed on opening.

OFF = WING DELAY INHIBITED with wings starting at the same time.



DIP6 ON = control unit set up as SLAVE (see sect. 13).
OFF = control unit set up as MASTER (see sect. 13).



DIP7 ON = "DOUBLE WING DOOR" OPERATING MODE (see sect. 13).
OFF = "SINGLE WING" OPERATING MODE.



DIP 8 The combination of these dip switches obtains the operating mode of photocell module.



DIP9 Consult section 12 for the relative description.
If photocell is not used, keep the dipswitch OFF as in the default setting.



DIP 10 ON = The INTERNAL RADAR input controls closing only.
The EXTERNAL RADAR input controls opening only.

After an opening controlled by the EXTERNAL RADAR, closing is not automatic but occurs thanks to the intervention of the INTERNAL RADAR.

OFF = Standard operation of the radar inputs.

















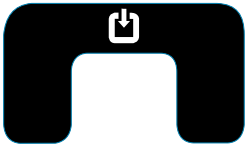

DIP 11 ON = Default values of the TECHNICAL MENU restored (see sect.18 ADVANCED FUNCTIONS - TECHNICAL MENU)

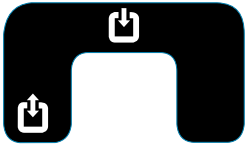

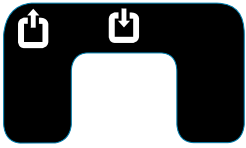
DIP 12 = RESET of the control unit:

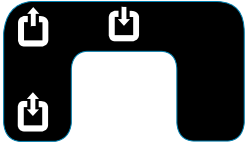
access the programming mode, set dipswitch 12 ON and quit, saving the data item as described in section 9.2.

8) POTENTIOMETER ADJUSTMENTS

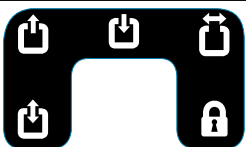
VIA CONTROL UNIT	FROM DIGITAL SELECTOR Note: If the program symbol is of a light colour, the led is on	WORK PARAMETERS
		Opening speed
		Closing speed
		Safety sensor inhibiting distance in opening mode
		Pushing thrust limitation
		Pause time - max 20" - min. 0
		Closing upkeep voltage
		Wind stop force intensity
TM8		Push & Go activating distance
TM9		Intensity of final thrust in last closing section to make it easier to fit into electro-lock
TM10		Power of 0.5 sec stroke on closing before opening to release electro-lock. At the minimum value, the closing stroke is inhibited and the electro-lock is activated at the same time as the motor starts.
		Remote control auto-learning (memorizing) Push the button on the remote control to save the code. The top row of input leds will flash simultaneously by way of confirmation.

IMPORTANT:

Adjustments that cannot be carried out by the control unit owing to the lack of further potentiometers can only be made via digital selector.

Consult sect. 9.2 for instructions about how to regulate the described parameters via digital selector.

9) DIGITAL SELECTOR

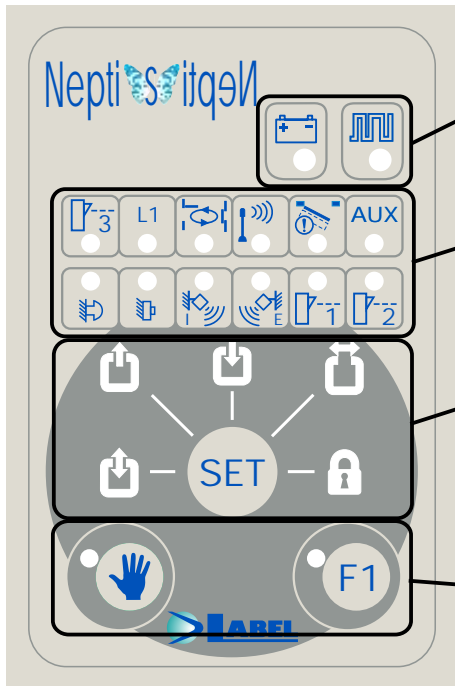



If the led  is permanently on or flashing, it means that there is no communication between the selector and the control unit..
In this case, check the electrical connection

Make sure that the LOGIC TAST module is installed.

Input status indication..
When on, the led indicates that the input is engaged.

Work program selection: press the SET button to change the type of program.
Clockwise, traffic in 2 directions, exit only, entrance only, doors always open, night lock

Press the key  (green led on) to activate the door free function.
The motor is not powered and the door can be moved by hand.

Press the key  (green led on) to inhibit the stepping function activated by dip-switch DIP 1 of S2.

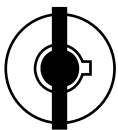

FREE FUNCTIONS (the work program can be changed by pressing SET)

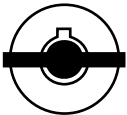

FUNCTIONS BLOCKED

LOGIC TAST

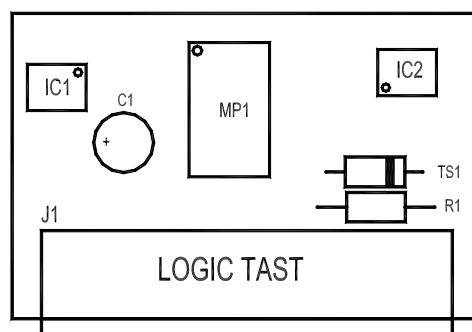

The package with digital selector also contains the LOGIC TAST electronic board, which is the interface module required for exchanging data between digital selector and the electronic control unit.

The LOGIC TAST board must be fitted into connector J8 of the LGN part of the electronic control unit (see fig.2 in sect. 2).

A 4-pin terminal board in the package is used for the electrical connection between digital selector and terminal board M4 of the PWN part of the electronic control unit.

9.1) THE REMOTE CONTROL

A radio receiver is built into digital selector. It can be used to control Label's SPYCO series remote controls with both one and three channels.

SPYCO remote controls transmit a rolling code (the code changes on each transmission according to a preset algorithm) and render the system immune to attempts to clone the code. The standard memory can store up to 250 remote controls (each remote control has a different code), while the optional memory can store 1000.

Refer to the drawing on the right, which illustrates the buttons.

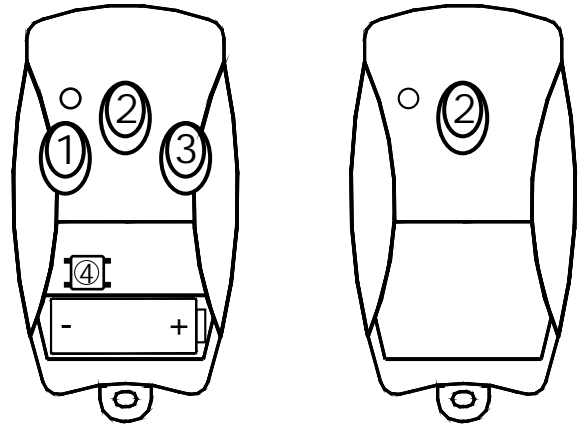

How to cancel all the codes

Comply with the following instructions to clear the memory of the receiver:

- Temporarily disconnect the selector from the electric power source.
- Press internal button P1 on the selector's circuit and keep it depressed.
- Connect the selector to the electric power source while keeping button P1 depressed.
- The leds of the inputs will now start to show that the memory cells are being cancelled. Release button P1.
- Once all the cells have been cancelled, the selector will operate in the normal way.

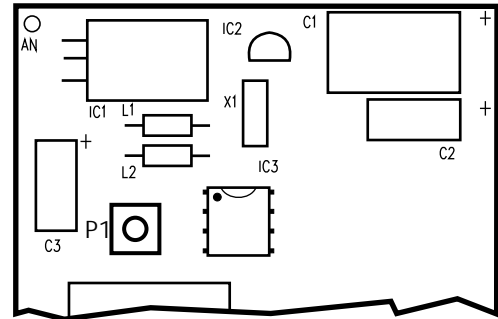



How to memorize a remote control

Comply with the following instructions to memorize a remote control:

- Access the remote programming mode as described in chapter 9.2 and go to the remote control autolearning function (see table in sect. 8).
- Press button ② on the remote control. The upper row of input leds will flash to confirm that programming has taken place.
- Quit the remote programming mode without memorizing as explained in chapter 9.2 from point Z onwards).

Use of the remote control





















Once the remote control has been memorized, the door can be opened with button ② of the SPYCO remote control. The pulse from the remote control is signalled by the relative led  on the selector and allows the door to be opened even in the night lock mode .

9.2) Adjusting the device with remote programming via digital selector

For the remote programming of DIP S1 and of potentiometers from TM1 to TM5 to become operative, DIP12 of S1 must be set to the ON position.

The programming of all other parameters does not depend on DIP 12 of S1.

Comply with the following instructions to access the programming mode:

- A) Move the selector's locking key to the functions locked position .
- B) Press the selector's SET  button and keep it depressed
- C) Move the locking key back to the functions free position .
- D) Release the SET button .
- E) The yellow leds of the inputs will come on from left to right in sequence, to indicate that the data are being loaded (UPLOAD).
- F) Once the UPLOAD phase has terminated, the red BATTERY led  and the yellow led  will come on.
- G) The battery led shows that work is being carried out on DIP-SWITCH S1 while the yellow led indicates:
 - G1) that DIP1 of S1 is in the ON position issues an unbroken light
 - G2) that DIP1 of S1 is in the OFF position if the led flashes.
- H) Press the door free button  to change the status of the DIP-SWITCH (ON - OFF).
- I) Press button F1 to move to DIP2 of S1 .
- L) Repeat the last operation to move to the other DIP-SWITCHES of S1.
- M) Refer to sections 6 and 7 for the meaning of the DIP-SWITCHES.
- N) To operate on DIP-SWITCH S2, press the SET  button. The LINE led  will come on.
- O) Repeat the operations as given for MINIDIP S1 to select and change the status of the individual DIP-SWITCHES.
- P) Press the SET button  to move to POTENTIOMETER TM1. The 2-WAY traffic led will come on! .
- Q) When the potentiometers are being used, the input leds form a scale to indicate the set value.
- R) To change the value of the selected potentiometer, press:
 - R1) the DOOR FREE button  to decrease the value.
 - R2) the F1 button  to increase the value.
- S) Press the SET button  to move to POTENTIOMETER TM2.
- T) Repeat this last operation to move to the other potentiometers.
- U) Refer to section 8 for the meaning of the potentiometers.
- V) Comply with the following instructions to quit the programming phase and memorize the changed values:
 - V1) Move the selector's locking key to the functions locked position .
 - V2) Press the selector's SET button and keep it depressed  del selettore.
 - V3) Move the locking key back to the functions free position .
 - V4) Release the SET button .
 - V5) The leds of the inputs will come on from right to left in sequence to indicate DOWNLOAD.
 - V6) The control unit will issue 2 bips once the DOWNLOAD phase has terminated
 - V7) The selector will set back to the normal operating mode.
- Z) Comply with the following instructions to quit the programming phase and without memorizing the changed values
 - Z1) Move the selector's locking key to the functions locked position .
 - Z2) Move the locking key back to the functions free position .
 - Z3) The selector returns on normal operation and the control unit issues one single bip.

10) COURTESY MODE FOR THE DISABLED

- Move dipswitch 8 of S1 to the ON position to enable the courtesy function for disabled persons. Two inputs of the "NEPTIS/LE" unit, i.e. START and EMERGENCY, are dedicated to the use of special opening buttons able to be used by disabled persons.
- After an opening phase has been activated by a disabled person by means of the START or EMERGENCY input, the door automatically closes again after the pause time set by potentiometer TM5 and the closing safety photocell input activates. If the closing safety photocell is obscured in the last section of the opening manoeuvre or during the door open pause time whilst a disabled person is crossing the threshold, the pause time is reduced to three seconds (even if a longer time has been selected) and the door consequently closes again.
- If the door is opened by manually pushing it with the push & go function enabled (DIP 1 of S1 ON), or by means of the internal or external radar, if used, the door will immediately close again with a pause time at its minimum value (even though potentiometer TM5 has been set for a longer time), while the closing safety photocell input will not be activated.

11) ELECTRO-LOCK RELEASE WITH FREE DOOR

Set dipswitch 2 of S2 to the ON position (see sect. 7) by means of digital selector (see a description of the procedure in sect. 9.2) to enable the electro-lock release with free door function.

Activate the FREE DOOR  function by means of the program selector to obtain a releasing pulse on the electro-lock if the door is shut and at the end of each closing phase, so as to prepare the door for being opened when pushed by hand the next time.

Use digital selector and press key  (green led on) to automatically release the electro-lock at the end of each door-closing phase in all the day functions.

Press key  (green led off) to inhibit the option.

WARNING!

It is inadvisable to activate the function (DIP 2 S2/ON) by using manual selector, as a variation in the door's operating program can lead to an undesired release of the electro-lock even when the function selected is not FREE DOOR.

This is due to the electrical commutation of the signals on the inputs of the control unit as the knob of selector SMN is moved.

12) PHOTOCELL BOARD

HOW TO INSERT THE BOARD INTO THE CONNECTOR ON THE MOTHERBOARD

Insert the photocell board into connector J9 (PHOTOCELL CONTROL) of motherboard LGN.

HOW TO DISTINGUISH THE TRANSMITTERS FROM THE RECEIVERS

Each pair of photocells comprises a receiver and a transmitter with a dedicated lead complete with mini-connector for fast and practical replacement. The receivers are square in shape in the part where the connecting wire projects, while the transmitters are round. An 11 mm diameter hole is required by both for fixing purposes. The wires are marked at both ends with the letters TX for transmitters and RX for receivers.

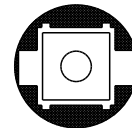

RECEIVER



TRANSMITTER

HOW TO SELECT THE NUMBER OF PHOTOCELL PAIRS TO USE

Board can handle up to 3 pairs of photocells, of which 2 pairs (FT1/FR1 and FT2/FR2) control door opening and operate in the same way as the radar inputs, while the third pair (FT3/FR3) operates as a closing safety photocell.

The combination of dipswitches must be correctly selected in the "NEPTIS/LE" control unit and module depending on the number of pairs of photocells used and their effective use.

Carefully consult the following table.

TABLE 12.1

DIP SWITCH S2 "NEPTIS/LE" CONTROL UNIT (to be set with digital selector)		DIP SWITCH SW1 PHOTOCELL BOARD		NUMBER OF PHOTOCELLS INSTALLED AND THEIR USE
DIP8	DIP9	DIP1	DIP2	
OFF	ON	OFF	ON	1 CLOSING SAFETY PAIR (FT3/FR3)
ON	ON	OFF	OFF	1 PAIR AS OPENING CONTROL (FT1/FR1)
ON	ON	ON	OFF	2 PAIRS AS OPENING CONTROL (FT1/FR1 & FT2/FR2)
ON	ON	OFF	ON	1 PAIR AS OPENING CONTROL (FT1/FR1) and 1 CLOSING SAFETY PAIR (FT3/FR3)
ON	ON	ON	ON	2 PAIRS AS OPENING CONTROL (FT1/FR1 & FT2/FR2) and 1 CLOSING SAFETY PAIR (FT3/FR3)

OPERATING MODE OF THE PAIRS OF PHOTOCELLS

FT1/FR1: same operation as the INTERNAL RADAR input.

FT2/FR2: same operation as the EXTERNAL RADAR input.

FT3/FR3: safety photocell. Operates during the closing phase, by reversing the direction of the door.

RECEIVER AND TRANSMITTER CONNECTIONS

To avoid interference due to direct sunlight, the receivers should be installed on the more sheltered side.

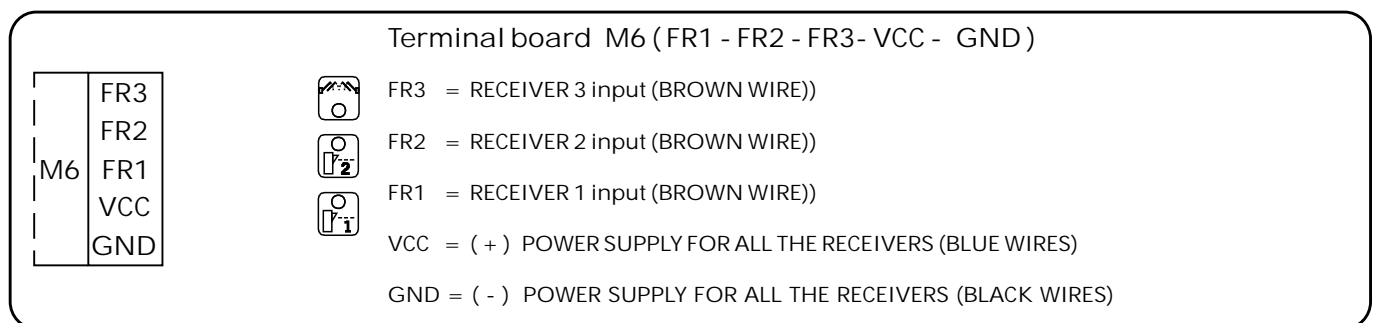
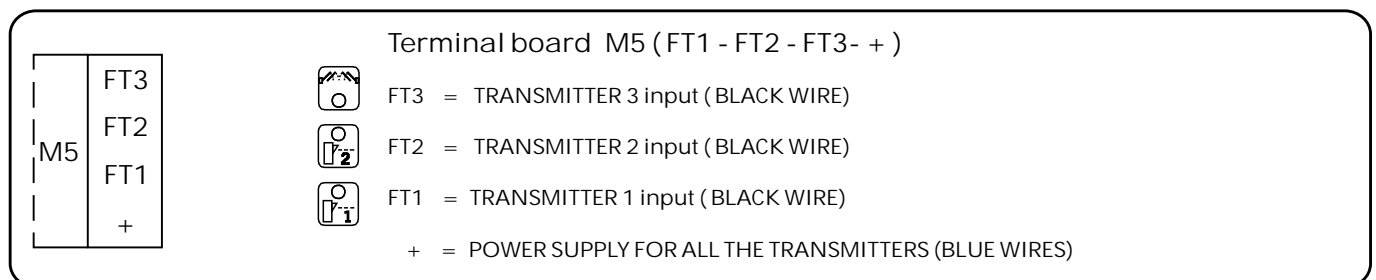

SENSITIVITY ADJUSTMENT

Once the photocells have been positioned, their sensitivity must be regulated by means of the potentiometer on the board. Proceed in the following way:

- 1) Calibrate the potentiometer depending on the distance between the photocells (see figure alongside).
- 2) If the leds on the photocells are off, their sensitivity is correct.
- 3) If the leds are on, slowly turn the potentiometer towards its maximum setting until the leds go out.
- 4) Check to make sure that the relative leds come on by breaking the infrared beam of the photocells.

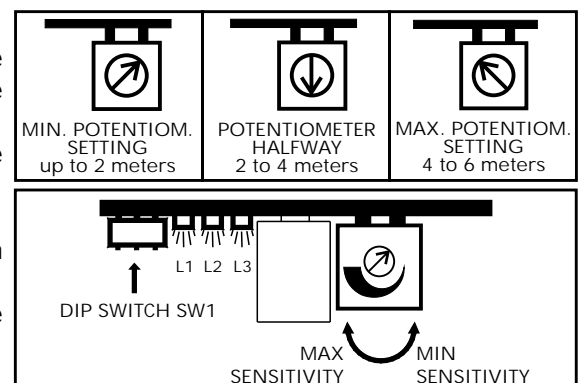

13) SWING DOOR WITH TWO WINGS



A door with two wings can be controlled by using two "NEPTIS/LE" actuators. Carefully consult the drawings in the "MECHANICAL SECTION" at the beginning of this manual in order to establish the fixing dimensions, opening direction of the wing and the maximum weight allowed by the wing length. The system comprises a main control unit, which must be configured as the MASTER and whose task is to handle the general operation of the door, and a second control unit configured as the SLAVE, which receives orders and information from the MASTER.

If one of the door wings overlaps the other during the closing phase, the actuator configured as the MASTER should be applied to the wing that overlaps the other (i.e. the wing that is the first to open and the last to close).

13.1) ELECTRICAL CONNECTIONS (see indicative diagram in figure 3)

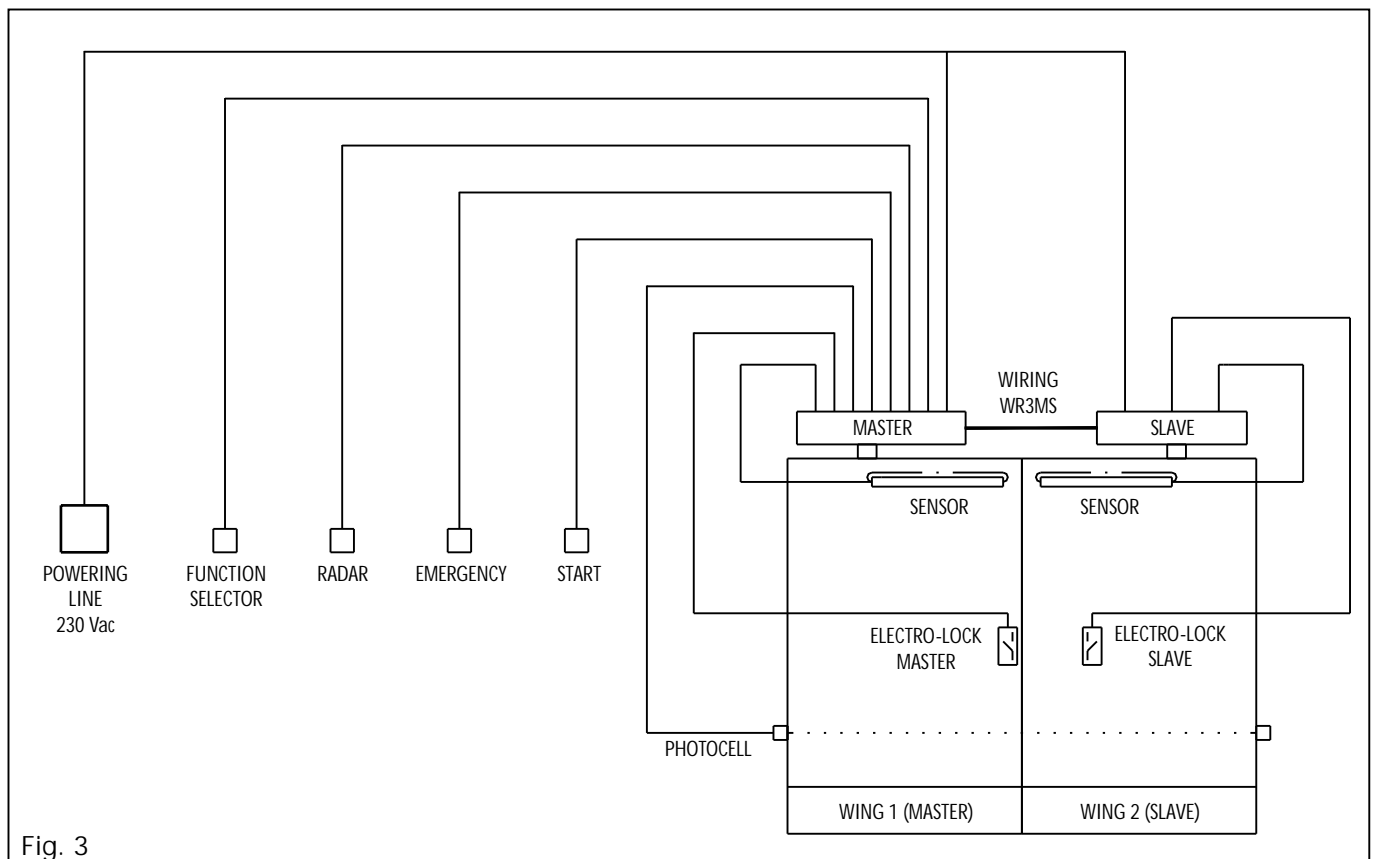

Fig. 3

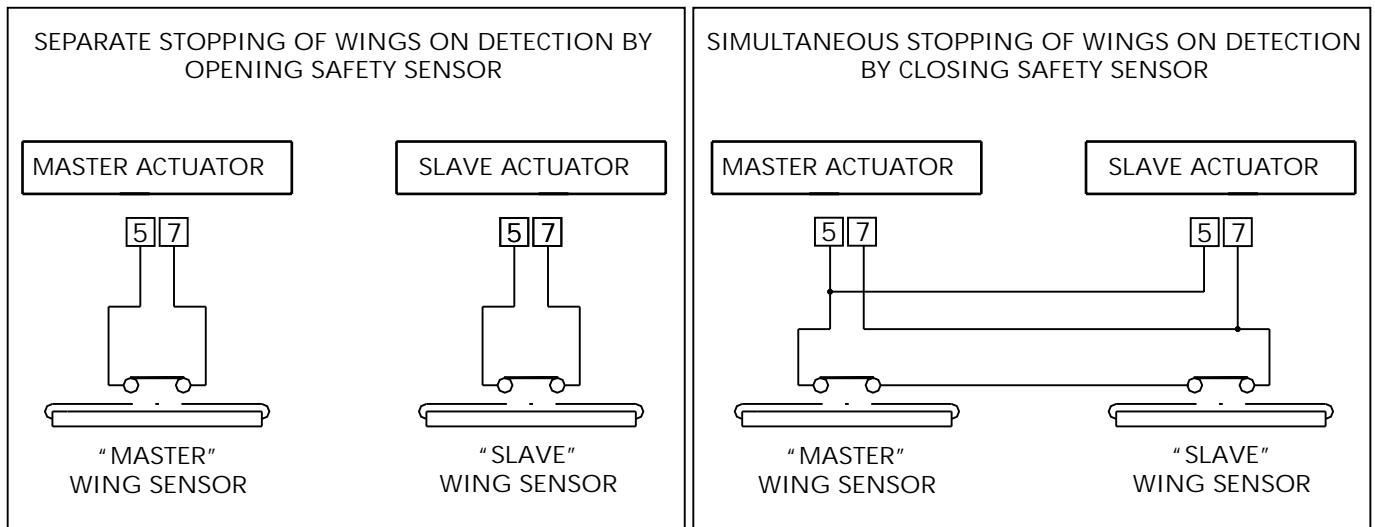

Fig. 4

13.1.1) ACTUATOR WITH MASTER CONTROL UNIT

Make the electrical connections to the MASTER control unit as described in sect. 1 of this manual, considering that all the control and safety inputs (from terminal 1 to terminal 11) are activated on the MASTER actuator. When it comes to the mod.SSS1 opening safety sensor, remember that the MASTER and SLAVE control units handle the detection phase in a separate way (see fig. 4). This means that the safety sensor applied to the wing controlled by the MASTER actuator must be connected between terminals 5-7 of the master control unit and will only influence the actions of this latter. If an opening safety sensor is used for both wings and the door must be completely stopped regardless of the sensor that detected the obstruction, the N.C. contacts of the two sensors must be connected in series with each other and the obtained contact must be routed to terminals 5-7 of the MASTER and SLAVE control units, making a parallel connection.

The electro-lock must be connected to the MASTER control unit.

Only the electro-lock that concerns the wing controlled by the master actuator should be connected to the MASTER control unit if the door has a double electro-lock to block each wing individually.

Mechanical program selector SMN (see section 5.2) should be connected to the MASTER control unit.

digital selector (see section 9) must be connected to the MASTER control unit so that the required operating program can be selected.

13.1.2) ACTUATOR WITH SLAVE CONTROL UNIT

Power the SLAVE control unit at 230V a.c. via terminal board M1.

Opening safety sensor mod.SSS1 installed on the wing controlled by the SLAVE actuator must be connected between terminals 5-7 of the SLAVE control unit and will only influence the actions of this latter (see figure 4).

Only connect the electro-lock that concerns the wing controlled by the SLAVE actuator if the door has a double electro-lock that blocks each wing individually.

IMPORTANT!

The MASTER and SLAVE control units must be connected together with the mod.WR3MS wiring for communication and data exchange purposes. Connect the two terminals at the end of the cable to the connectors marked J13 on the control units (logic part LGN).

13.2) HOW TO INSTALL THE DEVICE

Strictly comply with the instructions given below in order to install the device in the correct way:

- A) Fix the two "NEPTIS/LE" actuators in compliance with the dimensions and wing opening direction shown in the drawings in the mechanical section of this manual.
- B) To effect the connection of the arms choose the ideal load of the spring depending on the leaf characteristics as described in the paragraph 8.0 of the mechanical part.
- C) Make the initial set-up as described in sect. 4. Proceed separately, first with the actuator to be configured as the MASTER and then with the SLAVE. If one of the door wings overlaps the other during the closing phase, keep the wing controlled by the MASTER actuator open at the end of the initial set-up so as to allow the wing controlled by the SLAVE actuator to move freely during its initial set-up.
- D) Close both wings and select the functions suited to the operating mode for double-wing doors. The relative instructions are given in the next chapter.

13.3) FUNCTIONS AND ADJUSTMENTS

After installing the device and completing the initial set-up, proceed with the adjustments by selecting the parameters required to synchronize the system.

13.3.1) HOW TO ADJUST THE MASTER ACTUATOR

- A) Connect digital selector to the MASTER control unit without forgetting to fit the LOGIC TAST module into connector J8 of the control unit.
- B) Access the programming mode via digital selector (the procedure is explained in sect. 9.2), then go to dipswitch S2 (see sect. 7).
- C) If the door wing must be delayed on starting (overlapping wings), set dipswitch 5 ON, otherwise set dipswitch 5 OFF if the wings must both move at the same time.
- D) Set dipswitch 6 OFF to configure the control unit as the MASTER.
- E) Set dipswitch 7 ON to enable the control unit to operate in the "DOUBLE WING DOOR" mode.
- F) Quit the programming function via digital selector, memorizing the data (the procedure is described in sect. 9.2). The control unit issues 2 beeps.
- G) The control unit has now been set up to operate as MASTER for a door with two wings.

13.3.2) HOW TO ADJUST THE SLAVE ACTUATOR

- A) Connect digital selector to the SLAVE control unit, without forgetting to fit the LOGIC TAST module into connector J8 of the control unit
- B) Access the programming mode via digital selector (the procedure is explained in sect. 9.2) and go to dipswitch S2 (see sect. 7).
- C) Set dipswitch 6 ON to configure the control unit as the SLAVE.
- D) Set dipswitch 7 ON to enable the control unit to operate in the "DOUBLE-WING DOOR" mode.
- E) Quit the programming function via digital selector, memorizing the data (the procedure is described in sect. 9.2). The control unit issues 2 beeps.
- F) The control unit has now been set up to operate as SLAVE for a door with two wings.

13.3.3) HOW TO CHECK THE WAY THE DOOR OPERATES

- After having powered the two actuators, select the required function with the dipswitches and adjust the potentiometers as described in sect. 6, 7 and 8. Remember that some of the settings must only be made on the MASTER control unit while others must be made on both the MASTER and SLAVE.

Carefully consult the TABLE in sect. 15, which shows, for each parameter, whether the adjustment concerns both the control units or just the MASTER.

- If the door wings must be delayed on starting, set potentiometer TM2 (closing speed) of the MASTER control unit to a lower level (about half) than potentiometer TM2 of the SLAVE control unit. However, the MASTER actuator will start closing at a lower speed so that the SLAVE actuator can access the final wing slowing phase without reaching the overlapping point of the wings during its travel. If, during the closing phase, the wings should near each other below the selected delay time owing to sudden friction for example, the direction of the wings would be reversed.
- Lastly choose the required work program with the function selector device used (manual selector, digital selector or the simple function selector switch). Remember that this latter must be connected to the MASTER control unit.
- Now check the movement of the door by activating the opening manoeuvre and making sure that all the control and safety parts of the device operate correctly

To change the preset delay between the wings, use digital selector and connect it to the MASTER control unit, then access the TECHNICAL MENU (see sect. 18 TECHNICAL MENU) and modify the values in points 13 (wing delay on opening) and 14 (wing delay on closing). The hold time with the door open must only be regulated by potentiometer TM5 of the MASTER control unit.



WARNING:

If digital selector displays the following condition, it means that a communication fault has been detected between the MASTER and SLAVE control units. If this happens, check the connections of wiring WR3MS in both control units, check the settings made on dipswitches 6 and 7 of S2 and reset the system.

If digital selector is not used, lack of communication between the two control units would be shown by the fact that the MASTER actuator would remain open and the SLAVE closed.

14) PEDESTRIAN OPENING

The pedestrian opening function can only be used for a swing door with two wings. It is therefore essential for the actuators to be set up for operation as a DOUBLE-WING DOOR (see sect.13).

To enable the PEDESTRIAN OPENING function, set dipswitch 4 of S2 ON and select the condition which activates the function by means of dipswitch 3 of S2.

- A) DIP 3 S2 DIP 4 S2
 OFF ON

Choose  on the program selector to enable the PEDESTRIAN OPENING function.

- The  status loses its original free door function in this condition.

- B) DIP 3 S2 DIP 4 S2
 ON ON

Choose  on the program selector to enable the pedestrian opening FUNCTION.

- The  status loses its original minight lock function in this condition.

In both case A) and B), activation of an internal or external RADARinput partially opens the door, i.e. the sole wing controlled by the MASTER actuator (pedestrian wing), while the START or EMERGENCY inputs open both MASTER and SLAVE wings.

manual pushing with the push & go function only opens the pedestrian wing.

15) LIST OF PARAMETERS TO SELECT FOR THE CONTROL UNITS

PARAMETERS		
DIP-SWITCH S1	MASTER	SLAVE
DIP 1 = PUSH & GO	●	●
DIP 2 = WIND STOP	●	●
DIP 3 = CYCLIC FUNCTION (repeated opening and closing)	●	
DIP 4 = ELECTRO-LOCK OPERATING MODE	●	●
DIP 5 = CLOSING BY SPRING AND MOTOR	●	●
DIP 6 = INITIAL SET-UP	●	●
DIP 7 = DOOR OPEN/NIGHT LOCK (with function selector switch on II)	●	
DIP 8 = COURTESY MODE FOR THE DISABLEDI	●	
DIP 9 = 10 sec OPENING WITH "NIGHT LOCK" WORK PROGRAM	●	
DIP 10 = AUTOMATIC INCREASE OF THE HOLD TIME	●	
DIP 11 = SELECTION OF THE FUNCTION SELECTOR DEVICE	●	
DIP 12 = ADJUSTMENT OF FUNCTIONS & POTENTIOMETERS VIA SELECTOR	●	●

DIP-SWITCH S2	MASTER	SLAVE
DIP 1 = STEPPING MODE	●	
DIP 2 = ELECTRO-LOCK RELEASE IN FREE DOOR MODE	●	●
DIP 3 = PEDESTRIAN OPENING WITH FREE DOOR (OFF)/NIGHT LOCK (ON)	●	
DIP 4 = PEDESTRIAN OPENING FUNCTION	●	
DIP 5 = WING DELAY ON STARTING	●	
DIP 6 = MASTER/SLAVE CONTROL UNIT SET-UP	●	●
DIP 7 = "DOUBLE-WING DOOR " OPERATING MODE	●	●
DIP 8 = PHOTOCCELL OPERATING MODE	●	
DIP 9 = PHOTOCCELL OPERATING MODE	●	
DIP 10 = OPERATION OF THE RADAR INPUTS	●	
DIP 11 = RESETING OF TECHNICAL MENU DEFAULT VALUES (see TECHNICAL MENU)	●	●
DIP 12 = CONTROL UNIT RESET	●	

POTENTIOMETERS	MASTER	SLAVE
TM1 = OOPENING SPEED	●	●
TM2 = CLOSING SPEED	●	●
TM3 = OPENING SAFETY SENSOR CUT-OUT DISTANCE	●	●
TM4 = PUSHING POWER LIMITATION	●	●
TM5 = HOLD TIME	●	
TM6 = UPKEEP VOLTAGE ON CLOSING	●	●
TM7 = WIND STOP FORCE INTENSITY	●	●
TM8 = PUSH & GO ACTIVATION DISTANCE	●	●
TM9 = INTENSITY OF FINAL CLOSING PUSH TO LINK ELECTRO-LOCK	●	●
TM10 = POWER OF CLOSING STROKE FOR RELEASING ELECTRO-LOCK	●	●

TECHNICAL MENU		
PARAMETERS	MASTER	SLAVE
1) PUSHING FORCE AT THE BEGINNING OF THE CLOSING MANOEUVRE (on closing)	●	●
2) DISTANCE AT THE BEGINNING OF THE CLOSING MANOEUVRE (on closing)	●	●
3) NOT USED		
4) NOT USED		
5) END OF TRAVEL DISTANCE ON OPENING	●	●
6) PUSHING POWER AT END OF OPENING MANOEUVRE	●	●
7) PUSHING POWER AT END OF CLOSING MANOEUVRE ("NEPTIS/LE" version only)	●	●
8) NOT USED		
9) PUSHING TIME AT END OF CLOSING MANOEUVRE ("NEPTIS/LE" version only)	●	●
10) SLOWING DISTANCE ON OPENING	●	●
11) SLOWING DISTANCE ON CLOSING	●	●
12) WINF STOP FORCE INTENSITY ON OPENING	●	●
13) WING DELAY ON START-UP IN OPENING PHASE	●	
14) WING DELAY ON START-UP IN CLOSING PHASE	●	

16) MEANINGS OF THE BUZZER SIGNALS (BEEPS)

- 5 BEEPS = control unit without initial set-up (press START with function selector switch in 0 position)
- Long BEEP = control unit without initial set-up (keeping START depressed with function selector switch on I or II)
- 6 BEEPS = ENCODER not operating or disconnected
- 1 BEEP = programming procedure accessed via digital selector
- 1 BEEP = programming procedure quitted via digital selector without memorizing the data
- 2 BEEPS = programming procedure quitted via digital selector with data memorized
- 1 long BEEP (5") = initial set-up terminated.



17) TECHNICAL SPECIFICATIONS

POWER SUPPLY	230Vac +/- 10%
Max. POWER EXT. ACCESSORIES	20W
TIPE OF OPERATION	Intensive use
OPERATING TEMPERATURE	-20°C / +50°C
PROTECTION DEGREE	IP22

18) ADVANCED FUNCTIONS - TECHNICAL MENU

The adjustments in the technical menu allow you to change the various door operating parameters. This is of use when the default settings are not the optimal ones.

digital selector must be available for access to the TECHNICAL MENU.

enter the program from digital selector, turn the key to the horizontal function locking position, press the two keys  and , and keep them depressed, then turn the key back to the vertical work position.

The yellow leds will come on in sequence from left to right, showing that data are being loaded. After this, the red battery led and the yellow led of photocell 3 will come on.



The digital selector will now be operating on dip-switch 1 of switch S1, thus in the adjustment phase described in section 6.

Press the SET key 11 times to go to the end of the basic regolazione described in sect. 8 of the main instructions, i.e. the closing stroke strength (TM10).

This situation coincides with the beginning of the TECHNICAL MENU;

Press the SET button once to access the point 1 adjustment option:

similarly to the previous adjustments, the yellow leds form a scale that indicates the value entered.

Press the  key to decrease or the  key to increase this value.

1) PUSHING FORCE AT THE BEGINNING OF THE CLOSING MANOEUVRE



This is the pushing force at the beginning of the closing manoeuvre that helps the door to start moving when the force of the spring alone is unable to provide sufficient force on start-up. Increase the value to obtain a higher pushing power.

Press the SET key to access the point 2 adjustment option.

2) PUSHING DISTANCE AT THE BEGINNING OF THE CLOSING MANOEUVRE



This is the initial part of the closing manoeuvre in which the pushing power described in the previous point 1 is provided. It helps the door to begin moving on start-up. Increase the value to obtain a greater distance between the starting point on closing and the point in which the pushing power ceases.

Press the SET key to access the point 3 adjustment option.

3) NOT USED



Press the SET key to access the point 4 adjustment option.

4) NOT USED

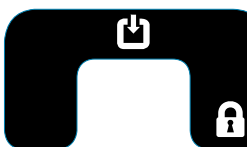

Press the SET key to access the point 5 adjustment option.

5) END OF TRAVEL DISTANCE ON OPENING

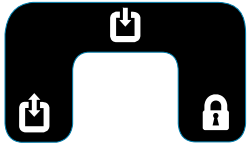

This is the distance between end of travel on opening and the final resting point. Increase the value to increase the distance.

Press the SET key to access the point 6 adjustment option.

6) PUSHING POWER AT END OF OPENING MANOEUVRE

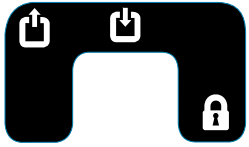

This is the pushing power in the last section of the opening phase. It is useful for preventing friction in the lock from being detected as an obstruction and preventing the manoeuvre from being completed.

Increase the value to obtain a higher power.

Press the SET key to access the point 7 adjustment option.

7) PUSHING POWER AT END OF CLOSING MANOEUVRE ("NEPTIS/LE" version only)

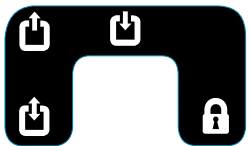

This is the pushing power in the last section of the closing phase. It is useful for preventing friction in the lock from being detected as an obstruction and preventing the manoeuvre from being completed.

Increase the value to obtain a higher power.

Press the SET key to access the point 8 adjustment option.

8) NOT USED



Press the SET key to access the point 9 adjustment option.

9) PUSHING TIME AT END OF CLOSING MANOEUVRE



This is the time for which the motor continues to push in the last closing section. It helps the door to reach its fully closed position by overcoming any friction.

Increase the value to lengthen the time.

Press the SET key to access the point 10 adjustment option.

10) SLOWING DISTANCE ON OPENING



This is the distance from the end of opening travel in which the door proceeds at a slower speed. Increase the value to increase the distance.

Press the SET key to access the point 11 adjustment option.

11) SLOWING DISTANCE ON CLOSING



This is the distance from the end of closing travel in which the door proceeds at a slower speed. Increase the value to increase the distance.

Press the SET key to access the point 12 adjustment option.

12) WIND STOP FORCE INTENSITY ON OPENING



Helps to keep the device in the “door open” status, preventing the wind or other causes from closing accidentally.
Increase the value to obtain a stronger force.

Press the SET key to access the point 13 adjustment option.

13) WING DELAY ON OPENING

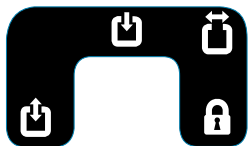

This parameter can only be adjusted after the “DOUBLE-WING DOOR” (dip 7 of dip-switch S2 ON) and “WING DELAY ACTIVATED” (dip 5 of dip-switch S2 ON) operating modes have been selected.
This adjustment must only be made on the main MASTER control unit (dip 5 of dip-switch S2 OFF). It is the SLAVE actuator’s delay on opening in relation to the MASTER actuator and is required if the wings overlap when they are closed.
Increase the value to obtain a longer delay on starting.

Press the SET key to access the point 14 adjustment option.

14) WING DELAY ON CLOSING



This parameter can only be adjusted after the “DOUBLE-WING DOOR” (dip 7 of dip-switch S2 ON) and “WING DELAY ACTIVATED” (dip 5 of dip-switch S2 ON) operating modes have been selected.
This adjustment must only be made on the main MASTER control unit (dip 5 of dip-switch S2 OFF). It is the MASTER actuator’s delay on closing in relation to the SLAVE actuator and is required if the wings overlap when they are closed.
Increase the value to obtain a longer delay on starting.

The adjustments that can be made via the technical menu have now terminated. The programming phase can thus be quitted and the data memorized in the following way:

- A) turn the key to the horizontal blocked position;
- B) press the SET key and keep it depressed;
- C) turn the key back to the vertical position and release SET;
- D) the yellow leds will flash from right to left to indicate that the data are being downloaded;
- E) at the end of this process, the control unit will issue 2 bips to indicate that the data are being memorized.

If you do not wish to memorize the changes, quit the programming status by simply turnign the key of the selector horizontally and move it back to the vertical position. The control unit will issue one single bip to show that the previous settings have not been changed.

IMPORTANT!

If the door fails to operate in the desired way after any one of the parameters in the TECHNICAL MENU has been changed and you wish to return to the original operating mode, proceed as described below:

A) access the programming mode by means of the selector:

B) set dip-switch 11  of switch  S2 to the on position, following the procedure described in sect. 9.2;

C) quit the programming mode and memorize the data. The control unit will issue 2 bips to indicate that the default values have been activated again.

notes

Nepti  itqelN

Made in Italy
by

